

MODULAR FLAT GATE VALVE TYPE SMFS-HD

SHUT-OFF - COMPONENT FOR SILO AND CONTAINER SYSTEMS WITH OPTIMAL SEALING – ELECTRO PNEUMATIC



The **modular gate valve TYPE SMFS-EP** is attached to silo and vessel discharges and assures the optimal sealing of stored dusty and granular bulk goods up to 8 mm in size. The pneumatically activated flat gate is normally used as a proportional slide gate. This modular gate allows the installation of various drive configurations - manual, pneumatic, or electric motor driven - on the same base frame.

Areas of Application

- Grain size up to 8 mm
- High quality gate plate sealing; packing box easily adjustable and exchangeable
- Slide plate made of stainless steel 1.4301, ground
- Steel guide on the slide gates upper side
- Ball track rollers sealed on both sides
- Large, easily removable protective covers
- Low overall height
- Ex-protected
- Special paintwork on request
- Special sizes on request
- High-temperature version
- position indicator
- Other materials: e.g. stainless steel 1.4301 / 1.4571

Details / Explanation

- Rust removal: SA 2,5
- Primer: 2K; 40µm
- Top coat: 2K; RAL 9006; 40µm

Finish

Spare parts drawing

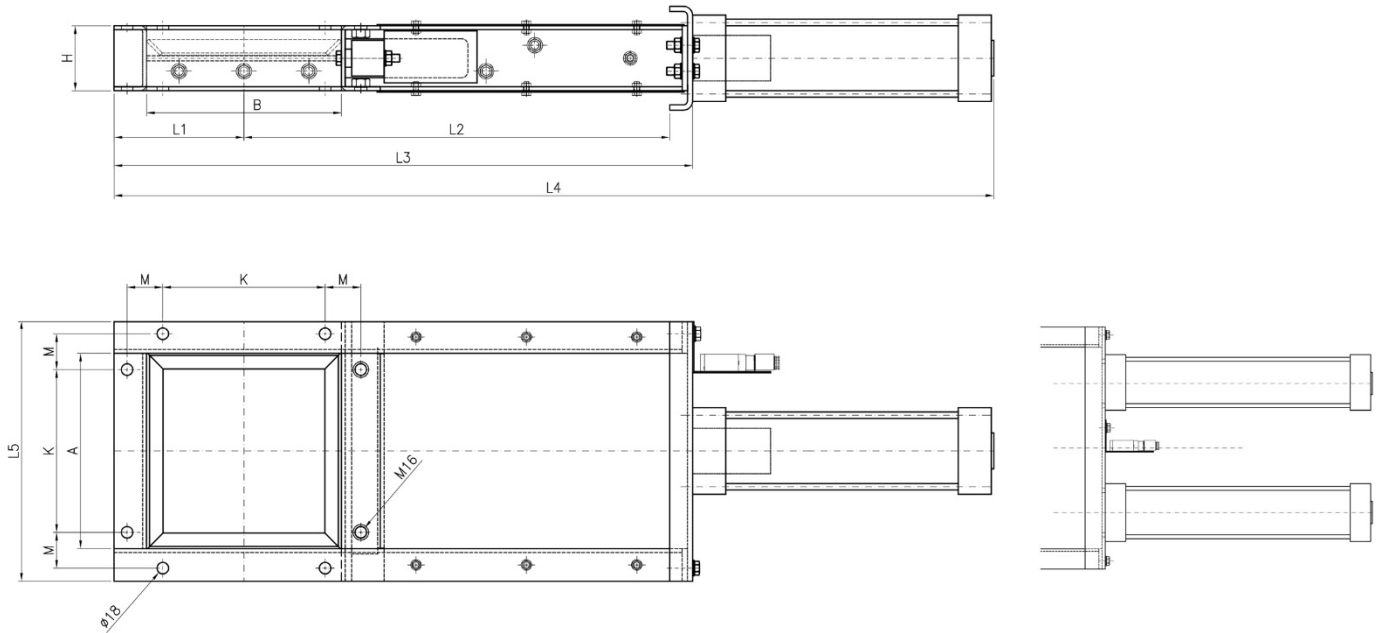

Dimensions Flat Gate Type SMFS - EP

AxB [mm]	Article No.	Weight [kg]	K [mm]	M [mm]	L1 [mm]	L2 [mm]	L3 [mm]	L4 [mm]	L5 [mm]	H [mm]	DxHub [mm]	d
200x200	712 10 279	48	150	55	150	500	690	1155	300	100	Ø100x200	1/4"
250x250	712 10 284	52	200	55	175	575	790	1255	350	100	Ø100x250	1/4"
300x300	712 10 268	55	250	55	200	650	890	1355	400	100	Ø100x300	3/8"
350x350	712 10 282	61	280	65	225	726	990	1545	450	100	Ø125x350	3/8"
400x400	712 10 273	65	300	80	250	800	1090	1645	500	100	Ø125x400	1/2"
450x450	712 10 302	84	330	90	275	881	1190	1855	550	100	Ø125x450	1/2"
500x500	712 10 276	95	350	105	300	950	1290	1955	600	100	2xØ125x50	1/2"
600x600	712 10 306	118	380	120	325	1025	1390	2055	700	120	2xØ125x60	1/2"











Subject to technical changes

Special solutions gate valve type SMFS - EP
Special sizes on request

Notice



Accessories / Spare parts

	Article No.	
Pneumatic cylinder	881 10 105	
Fork head	ST1779	
Reed switch for cylinders 24V DC / 230V AC	881 10 214	
Limit switches 24V/DC IG5533	881 10 270	
Limit switches 230V/AC IG0006	881 10 222	
Solenoid valve 5/2 24V/DC Standard	881 10 165	
Solenoid valve 5/2 230V/AC Standard	881 10 164	
Solenoid valve 5/3 24V/DC for intermediate position	881 10 177-01	
Solenoid valve 5/3 230V/AC for intermediate position	881 10 177-02	
Ball bearing - standard	712 10 143	

	Type	Article No.	
Stuffing box packing / Gasket Set for 1 slider (3 pieces)	SMFS 200 x 200	712 10 285	
	SMFS 250 x 250	712 10 286	
	SMFS 300 x 300	712 10 287	
	SMFS 350 x 350	712 10 288	
	SMFS 400 x 400	712 10 289	
	SMFS 450 x 450	712 10 290	
	SMFS 500 x 500	712 10 291	

	Type	Article No.	
Gasket block	SMFS 200 x 200	712 10 278 102	
	SMFS 250 x 250	712 10 294 102	
	SMFS 300 x 300	712 10 268 102	
	SMFS 350 x 350	712 10 282 102	
	SMFS 400 x 400	712 10 274 102	
	SMFS 450 x 450	712 10 296 102	
	SMFS 500 x 500	712 10 275 102	

	Type	Article No.	
Slide plate	SMFS 200 x 200	712 10 278 101	
	SMFS 250 x 250	712 10 294 101	
	SMFS 300 x 300	712 10 268 101	
	SMFS 350 x 350	712 10 282 101	
	SMFS 400 x 400	712 10 274 101	
	SMFS 450 x 450	712 10 296 101	
	SMFS 500 x 500	712 10 275 101	

Spare parts old version

	Type	Article No.	
Seal kit 2 x round felt + X x half round felt	flat slide 200 x 200	712 10 142	
	flat slide 250 x 250	712 10 064	
	flat slide 300 x 300	712 10 003	
	Flachschieber 400 x 400	712 10 058	
	flat slide 500 x 500	712 10 189	

Pressing device	712 10 251	
-----------------	------------	---------------------------------------------------------------------------------------